

5050



Luminária suspensa para aplicação em espaços interiores, com projeção de luz descendente. Corpo em alumínio extrudido com possibilidade de pintura em diversas cores. Difusor em policarbonato opalino. Driver incorporado. Florão standard: saliente redondo (outras opções disponíveis na página nº2).

Suspended luminaire for indoor application, with downward light projection. Extruded aluminum body with the possibility of painting in different colors. Polycarbonate diffuser in opal. Incorporated driver. Standard fleuron: round surface (other options available on page nº2).

Luminaria suspendida para aplicación interior, con proyección de luz descendente. Corps en aluminium extrudé avec possibilité de peinture en différents couleurs. Diffuser en polycarbonate opalino. Driver incorporado. Florón estándar: superficie redondo (outras opciones disponibles en la página nº2).

Luminaire suspendu pour application intérieure, avec projection de lumière descendant. Cuerpo de aluminio extruido con posibilidad de pintar en diferentes colores. Diffuseur en polycarbonate opale. Driver intégré. Fleuron standard: rond saillant (autres options disponibles page nº2).

APLICAÇÃO . APPLICATION . PROYECTOR . PROJECTEUR .



DESENHO TÉCNICO . TECHNICAL DRAWING . DISEÑO TÉCNICO . DESSIN TECHNIQUE .

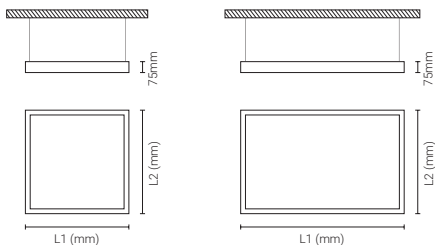

DETALHES TÉCNICOS . TECHNICAL DETAILS . DETALLES TÉCNICOS . DÉTAILS TECHNIQUES .

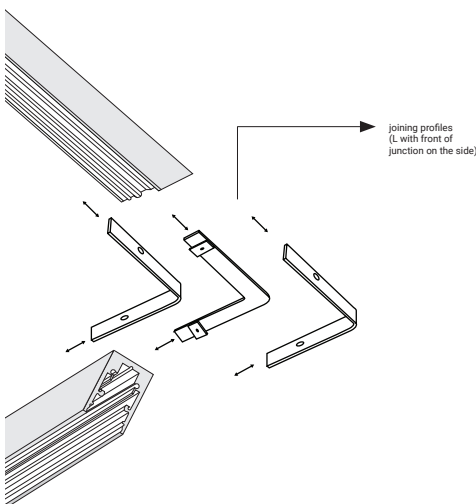

NORMAS . NORMS . NORMAS . NORMES .

Norms: EN 60598-1:2015, EN 60598-2-1:2012, IEC 60529, EN 50581:2012, IEC 61000-3-2:2014, EN 61547:2009

Directives: 2012/19/UE REEE, 2014/30/UE Electromagnetic Compatibility, 2014/35/UE Low Voltage

SISTEMA ELÉTRICO . ELECTRICAL SYSTEM . SISTEMA ELECTRICO . SYSTÈME ÉLECTRIQUE .



FONTE DE ALIMENTAÇÃO . POWER SUPPLY . FUENTE DE ALIMENTACIÓN . SOURCE D'ALIMENTATION .

DRIVER 220-240VAC · 50/60Hz

FONTE DE LUZ . LED INFORMATION . INFORMACIÓN LED . INFORMATIONS LED .

LED 2700K | 3000K | 4000K | 5000K | 6500K

MacAdam 3 · >50.000h @ L80.B10 · CRI 80

APLICAÇÃO | DIREÇÃO . APPLICATION | DIRECTION . APLICACIÓN | DIRECCIÓN . APPLICATION | DIRECTION .



Aplicação suspensa | Projeção de luz descendente
Suspended application | Downward light projection
Aplicación suspendida | Proyección de luz descendente
Application suspendue | Proyección de luz descendant

CORES . COLORS . COLORES . COULEURS .

- | | |
|-------|---|
| 1 | Branco . White . Blanco . Blanc . |
| 2 | Cinza . Gray . Cinza . Gris . |
| 3 | Cinza Satinado . Satin Gray . Gris Satinado . Gris Satin . |
| x0L 4 | Escovado . Brushed . Cepillado . Brossé . |
| 7 | Grafite . Graphite . Grafito . Graphite . |
| 9 | Preto . Black . Negro . Noir . |
| 0 | RAL sob consulta . RAL on request . RAL bajo consulta . RAL sur demande . |

ACABAMENTOS . FINISHES . ACABADOS . FINITIONS .

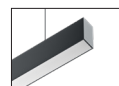



Opaline
Opal
Opaline

code:
5050.xxx.x0L

5050 | LED Module IP40

Code	L1 (mm)	L2 (mm)	Flow/Power 183lm/W
5050.064.xOL	640	640	8800 lm
5050.092.xOL	920	920	13200 lm
5050.120.xOL	1200	640	13200 lm
5050.148.xOL	1480	920	17600 lm

 code: 0Y00.000.OXX > Y+1

 code: 0Y00.000.OXX > Y+2

Pode ser instalado em linhas contínuas com o comprimento pedido. Outras medidas sob consulta.
Can be installed in continuous lines with the requested length. Other measures available under consultation.
Puede ser instalado en líneas continuas con la longitud solicitada. Otros comprimentos bajo pedido.
Peut être installé en lignes continues avec la longueur demandée. Des autres mesures disponibles sur demande.

EFICIÊNCIA ENERGÉTICA . ENERGY EFFICIENCY . EFICIENCIA ENERGETICA . EFFICACITÉ ÉNERGÉTIQUE .

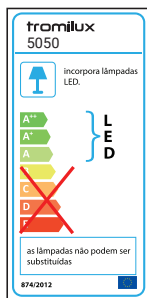

KIT DE EMERGÊNCIA OPCIONAL . OPTIONAL EMERGENCY KIT . KIT OPCIONAL DE EMERGENCIA . KIT D'URGENCE EN OPTION .



CABO DE SUSPENSÃO . SUSPENSION CABLE . CABLE DE SUSPENSIÓN . CÂBLE DE SUSPENSION .



5084.COS.xXX
Standard
1,5 metros

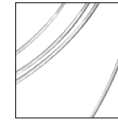

5084.CA2.xXX
Option 2 metros

5084.CA3.xXX
Option 3 metros

Outras medidas sob consulta . Other measures available under consultation .
Otros comprimentos bajo pedido . Des autres mesures disponibles sur demande .

FLORÃO . FINIAL . FLORON . FLEURON .

Saliente

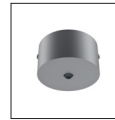

5084.FSR.xXX
Round surface
fleuron Standard/
Included

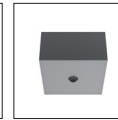

5084.FSQ.xXX
Squared surface
fleuron

Encastrada

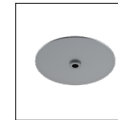

5084.FER.xXX
Round recessed
fleuron



5084.FEQ.xXX
Square recessed
fleuron